



**PARA LIGHT ELECTRONICS CO., LTD.**

4F, No.1, Lane 93, Chien Yi Road, Chung Ho City, Taipei, Taiwan, R.O.C.

Tel: 886-2-2225-3733

Fax: 886-2-2225-4800

E-mail: [para@para.com.tw](mailto:para@para.com.tw)

<http://www.para.com.tw>

DATA SHEET

PART NO. : L-51ROPT1D1

REV : A / 3

CUSTOMER'S APPROVAL : \_\_\_\_\_

DCC : \_\_\_\_\_

DRAWING NO. : DS-21-02-0005

DATE : 2005-01-26

Page : 1

PACKAGE DIMENSIONS

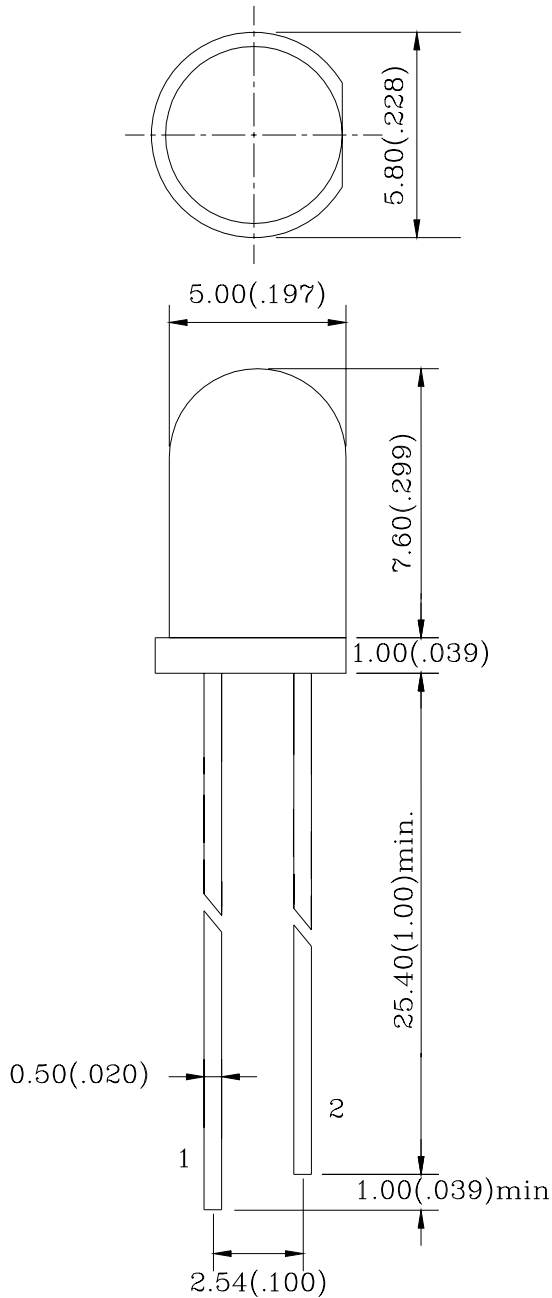

Note:

- 1.All Dimensions are in millimeters.
- 2.Tolerance is  $\pm 0.25\text{mm}$  (0.010 ") Unless otherwise specified.
- 3.Protruded resin under flange is 1.5mm (0.059 ") max.
- 4.Lead spacing is measured where the leads emerge from the package.
- 5.Specification are subject to change without notice.

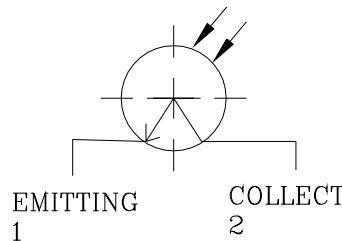



# 5.0 mm PHOTOTRANSISTOR

## L-51ROPT1D1

REV:A / 3

### FEATURES

- \* WIDE RANGE COLLECTOR CURRENTS
- \* LENSED FOR HIGH SENSITIVITY
- \* HIGH-OUTPUT POWER
- \*HIGH-SPEED RESPONSE

### CHIP MATERIALS

- \* SILICON

ABSOLUTE MAXIMUM RATING : ( Ta = 25°C )

SYMBOL	PARAMETER	MAX	UNIT
PAD	Power Dissipation Per Chip	10	mW
V(BR)CEO	Collector-Emitter Breakdown Voltage	30	V
Topr	Operating Temperature Range	-35°C to 85°C	
Tstg	Storage Temperature Range	-35°C to 85°C	
Lead Soldering Temperature { 1.6mm(0.063 inch) From Body } 260°C ± 5°C for 5 Seconds			

ELECTRO-OPTICAL CHARACTERISTICS : ( Ta = 25°C )

SYMBOL	PARAMETER	TEST CONDITION	MIN.	TYP.	MAX.	UNIT
BVCEO	Collector-Emitter Breakdown Voltage	Ic = 100µA Ee = 0 mw/cm <sup>2</sup>	30			V
BVECO	Emitter-Collector Breakdown Voltage	IE=100µA Ee= 0 mw/cm <sup>2</sup>	5			V
ICEO	Collector Dark Current	VCE=10V Ee=0 mw/cm <sup>2</sup>			100	nA
VCE(S)	Collector-Emitter Saturation Voltage	IC=2mA Ee=0.5 mw/cm <sup>2</sup>			0.4	V
TR/TF	Rise / Fall Time	VCE=5V IC=1mA RL=1000 Ω		15/15		uS
IC	On Stat Collector Current	VCE=5V Ee=0.1 mw/cm <sup>2</sup>		2		mA
λP	Spectral Sensitivity Wavelength			940		nm

Fig. 1 Collector Power Dissipation vs. Ambient Temperature

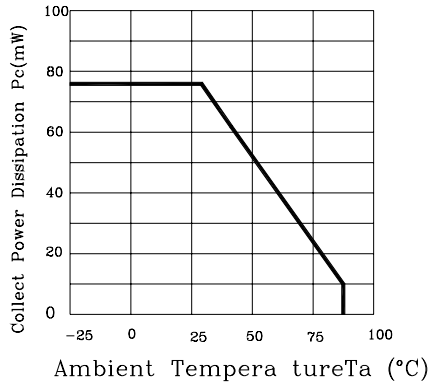

Fig. 2 Collector Dark Current  $I_{cD}$  (A) vs. Ambient Temperature

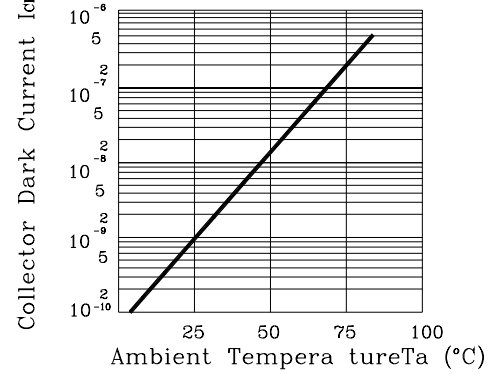

Fig. 3 Relative Collector Current vs. Ambient Temperature

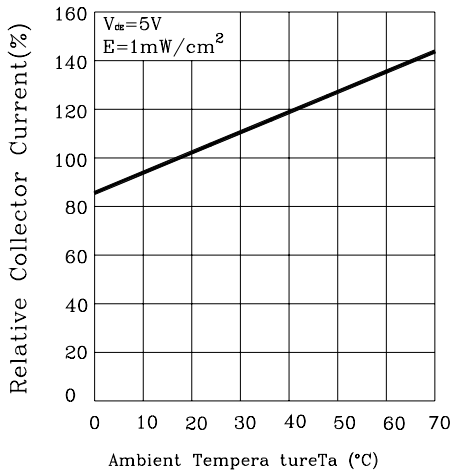

Fig. 4 Collector current vs Irradiance

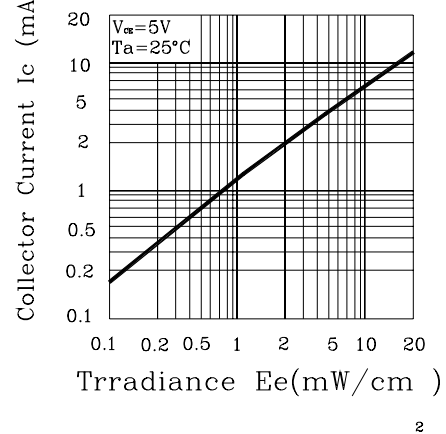

Fig. 5 Spectral Sensitivity

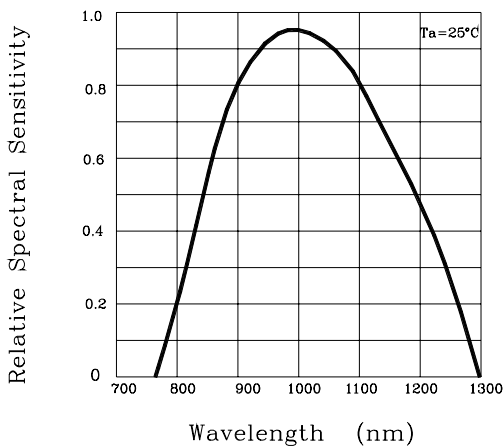
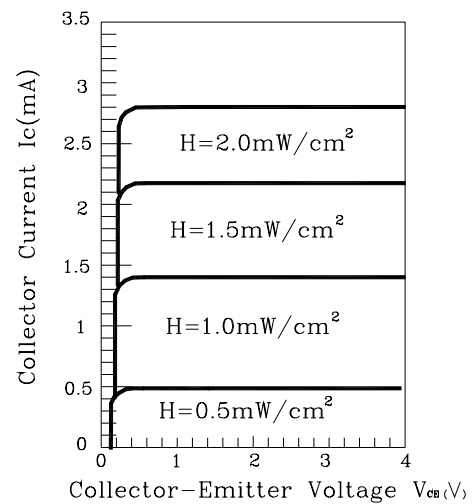

Fig. 6 Collector Current vs Collector-Emitter Voltage





5.0 mm PHOTOTRANSISTOR

L-51ROPT1D1

REV:A / 3

Label Explanation

 <b>光鼎电子股份有限公司</b> PARA LIGHT ELECTRONICS CO.,LTD.	
PARA NO. :	
LOT NO. :	INSPECTED
BIN :	
Q' TY :	PCS
N. W :	g

PARA NO. : Refer to p11

LOT NO. : **E L L 4 7 0009**

A B C D E F

A---E: For series number

B---L: Local F: Foreign

C---L: LAMP

D---Year

E---Month

F---SPEC.

BIN :

Q'TY : Below are standard specification, actual packing quantity reference page 12

N'W : Net Weight

**•SOLDERING**

METHOD	SOLDERING CONDITIONS	REMARK
DIP SOLDERING	Bath temperature: 260±5°C Immersion time: with 5 sec	<ul style="list-style-type: none"> <li>Solder no closer than 3mm from the base of the package</li> <li>Using soldering flux, "RESIN FLUX" is recommended.</li> </ul>
SOLDERING IRON	Soldering iron: 30W or smaller Temperature at tip of iron: 260°C or lower Soldering time: within 5 sec.	<ul style="list-style-type: none"> <li>During soldering, take care not to press the tip of iron against the lead.</li> </ul> (To prevent heat from being transferred directly to the lead, hold the lead with a pair of tweezers while soldering)

1) When soldering the lead of LED in a condition that the package is fixed with a panel (See Fig.1), be careful not to stress the leads with iron tip.

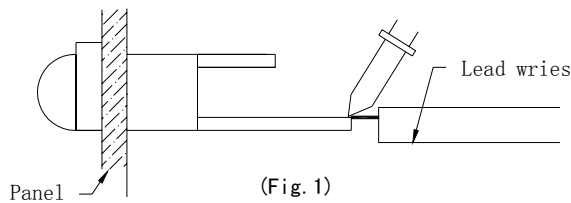

2) When soldering wire to the lead, work with a Fig (See Fig.2) to avoid stressing the package.

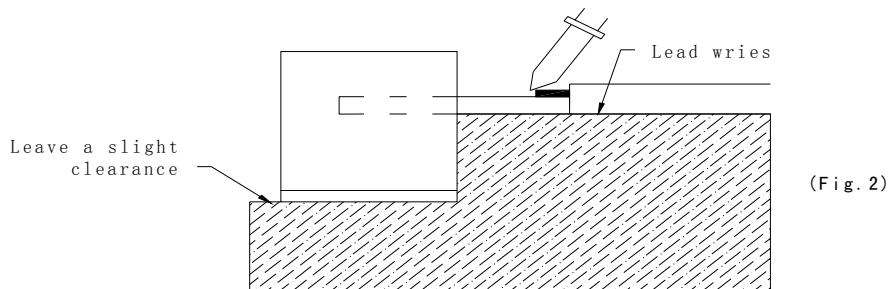

3) Similarly, when a jig is used to solder the LED to PC board, take care as much as possible to avoid steering the leads (See Fig.3).

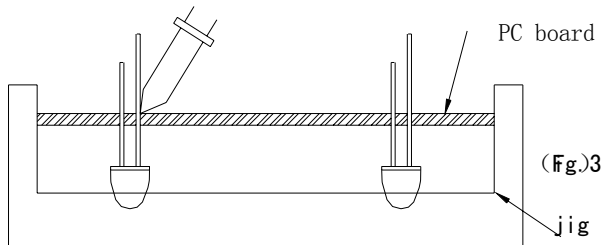

- 4) Repositioning after soldering should be avoided as much as possible. If inevitable, be sure to preserve the soldering conditions with irons stated above: select a best-suited method that assures the least stress to the LED.
- 5) Lead cutting after soldering should be performed only after the LED temperature has returned to normal temperature.

**•LED MOUNTING METHOD**

1) When mounting the LED by using a case, as shown Fig.4, ensure that the mounting holds on the PC board match the pitch of the leads correctly-tolerance of dimensions of the respective components including the LED should be taken into account especially when designing the case, PC board, etc. to prevent pitch misalignment between the leads and board holes, the diameter of the board holes should be slightly larger than the size of the lead. Alternatively, the shape of the holes should be made oval. (See Fig.4)

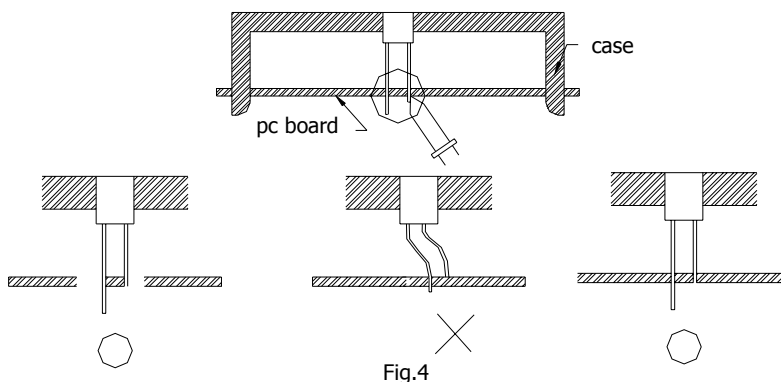

2) Use LEDs with stand-off (Fig.5) or the tube or spacer made of resin (Fig.6) to position the LEDs.

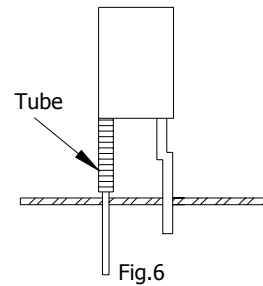
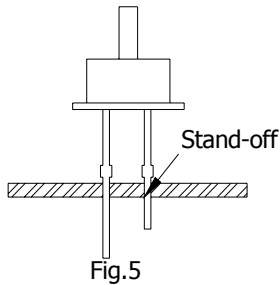

### ●FORMED LEAD

1) The lead should be bent at a point located at least 2mm away from the package. Bending should be performed with base fixed means of a jig or pliers (Fig.7)

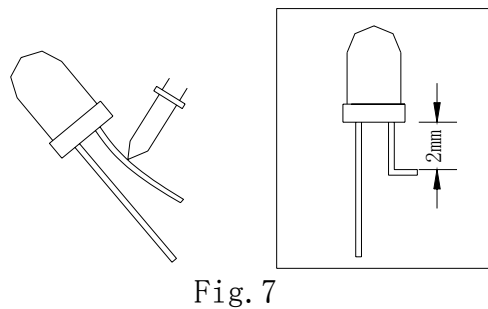

2) Forming lead should be carried out prior to soldering and never during or after soldering.  
3) Form the lead to ensure alignment between the leads and the hole on board, so that stress against the LED is prevented. (Fig.8)

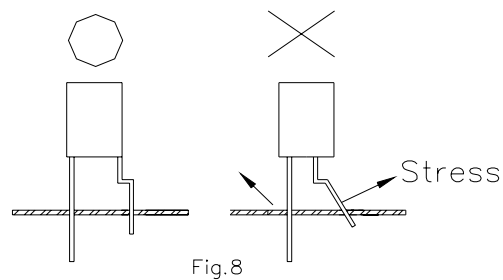



**•LEAD STRENGTH**

1) Bend strength

Do not bend the lead more than twice. (Fig.9)

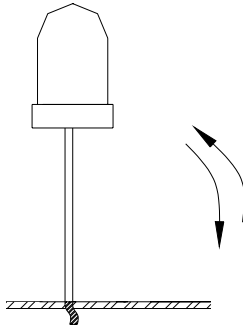

Fig.9

2) Tensile strength (@Room Temperature)

If the force is 1kg or less, there will be no problem. (Fig.10)

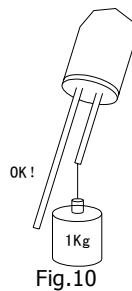

Fig.10

**•HANDLING PRECAUTIONS**

Although rigid against vibration, the LEDs may damaged or scratched if dropped. So take care when handling.

**•CHEMICAL RESISTANCE**

- 1) Avoid exposure to chemicals as it may attack the LED surface and cause discoloration.
- 2) When washing is required, refer to the following table for the proper chemical to be sued.  
(Immersion time: within 3 minutes at room temperature.)

SOLVENT	ADAPTABILITY
Freon TE	⊙
Chlorothene	×
Isopropyl Alcohol	⊙
Thinner	×
Acetone	×
Trichloroethylene	×

⊙--Usable    ×--Do not use.

NOTE: Influences of ultrasonic cleaning of the LED resin body differ depending on such factors as the oscillator output, size of the PC board and the way in which the LED is mounted. Therefore, ultrasonic cleaning should only be performed after confirming there is no problem by conducting a test under practical.

**Experiment Item:**

Item	Test Condition	Reference Standard
	Lamp & IR	
OPERATION LIFE	<p>Ta : 25±5°C            IF= 20mA RH : ≤60%RH            ① DYNAMIC:100mA 1ms 1/10 duty            ② STATIC STATE: IF=20mA            TEST TIME:            168HRS (-24HRS , +24HRS )            500HRS (-24HRS , +24HRS )            1000HRS (-24HRS , +72HRS )</p>	<p>MIL-STD-750 : 1026            MIL-STD-883 : 1005            JIS C 7021 : B-1</p>
HIGH TEMPERATURE HIGH HUMIDITY STORAGE	<p>Ta : 65°C±5°C            RH : 90~95%RH            TEST TIME : 240HRS±2HRS</p>	<p>MIL-STD-202 : 103B            JIS C 7021 : B-1</p>
TEMPERATURE CYCLING	<p>105°C ~ 25°C ~ -55°C ~ 25°C            30min 5min 30min 5min            10CYCLES</p>	<p>MIL-STD-202 : 107D            MIL-STD-750 : 1051            MIL-STD-883 : 1010            JIS C 7021 : A-4</p>
THERMAL SHOCK	<p>105°C±5°C ~ -55°C±5°C            10min 10min            10CYCLES</p>	<p>MIL-STD-202 : 107D            MIL-STD-750 : 1051            MIL-SYD-883 : 1011</p>
SOLDER RESISTANCE	<p>T , sol : 260°C±5°C            DWELL TIME : 10±1sec</p>	<p>MIL-STD-202 : 210A            MIL-STD-750-2031            JIS C 7021 : A-1</p>
SOLDERABILITY	<p>T , sol : 230°C±5°C            DWELL TIME : 5±1sec</p>	<p>MIL-STD-202 : 208D            MIL-STD-750 : 2026            MIL-STD-883 : 2003            JIS C 7021 : A-2</p>

**LED Lamps:**

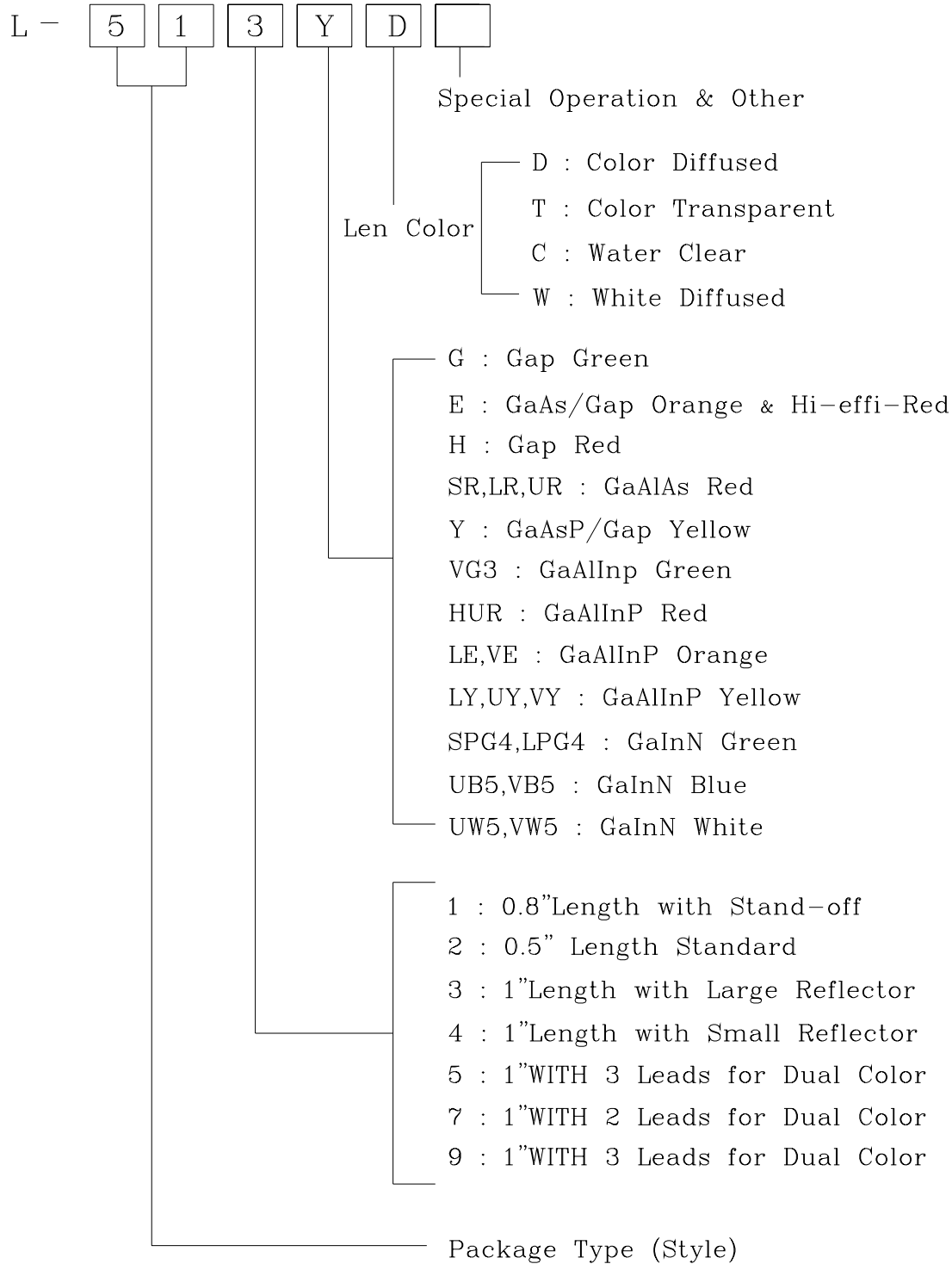

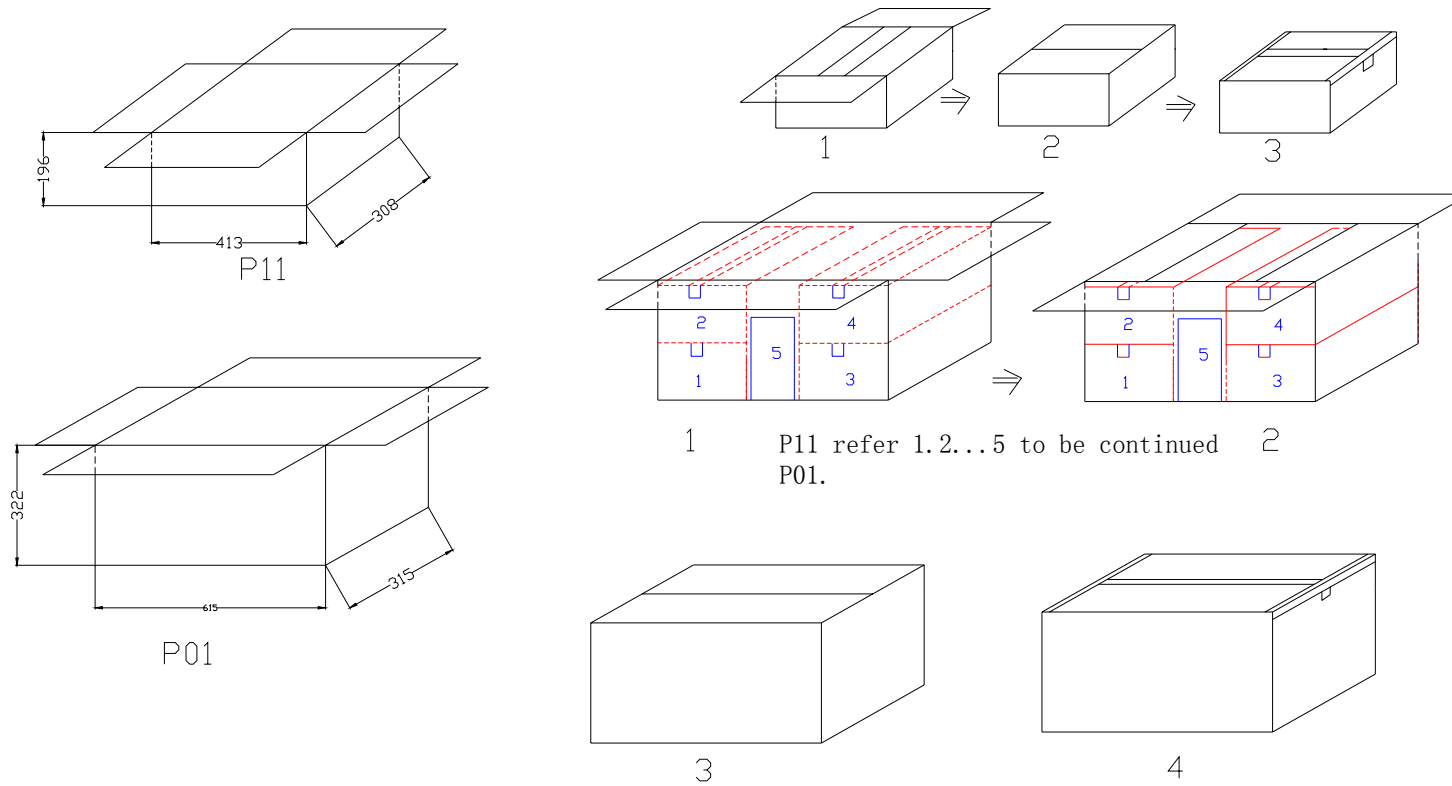

L-51ROPT1D1 package rule Note:

- 1、 P11 presents little package box ,10 little bags in every P11,1000PCS in every bag.
- 2、 P01 presents big package box, five little P11 boxes in every P01,total 50KPCS in every P01.
- 3、 Specific package course refers to the attached graph.